

Features

- Push-button diverter
- Includes faceplate with ADA-compliant metal cross handle
- Single cross handle allows for simultaneous on/off activation and temperature setting
- Coordinates with other products in the Artifacts collection

Material

- Premium metal construction for durability and reliability
- KOHLER finishes resist corrosion and tarnishing

Installation

- Trim only; requires K-11748-K or K-11748-KS Rite-Temp pressure-balancing valve (sold separately)
- Wall-mount



ADA

Codes/Standards







ASME A112.18.1/CSA B125.1
ADA
ICC/ANSI A117.1

KOHLER® Faucet Lifetime Limited Warranty

See website for detailed warranty information.

Available Colors/Finishes

Color tiles intended for reference only.

Color	Code	Description
	CP	Polished Chrome
	SN	Vibrant™ Polished Nickel
	BN	Vibrant™ Brushed Nickel
	BV	Vibrant™ Brushed Bronze
	2BZ	Oil-Rubbed Bronze
	2MB	Vibrant™ Brushed Moderne Brass

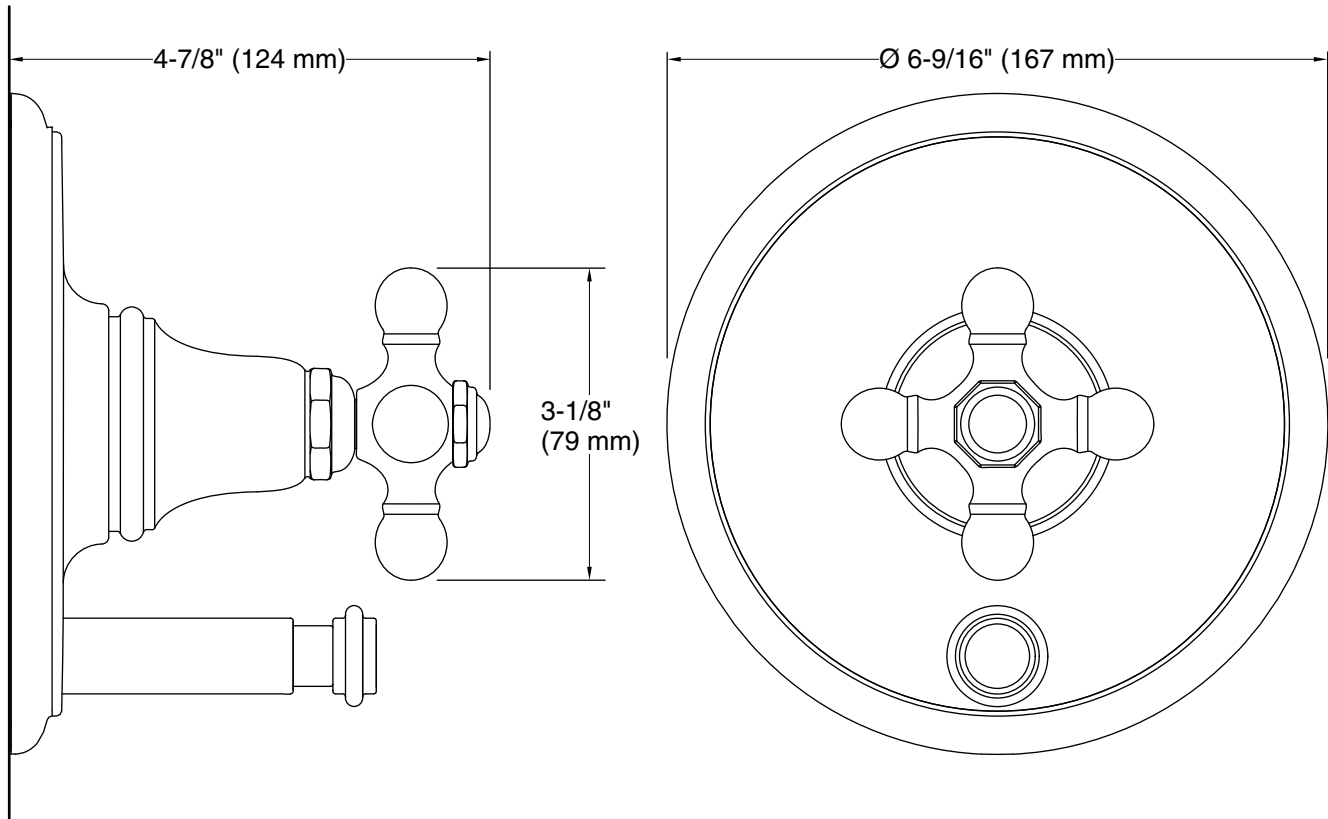

Technical Information

All product dimensions are nominal.

Drain included: No

Notes

Install this product according to the installation instructions.

ADA compliant when installed to the specific requirements of these regulations.